

MODEL1724C/1734C

GD-1720C Operator's Guide

The purpose of this guide is to provide the basic operating procedures for this equipment. For more detailed information, see the Operator's Manual.

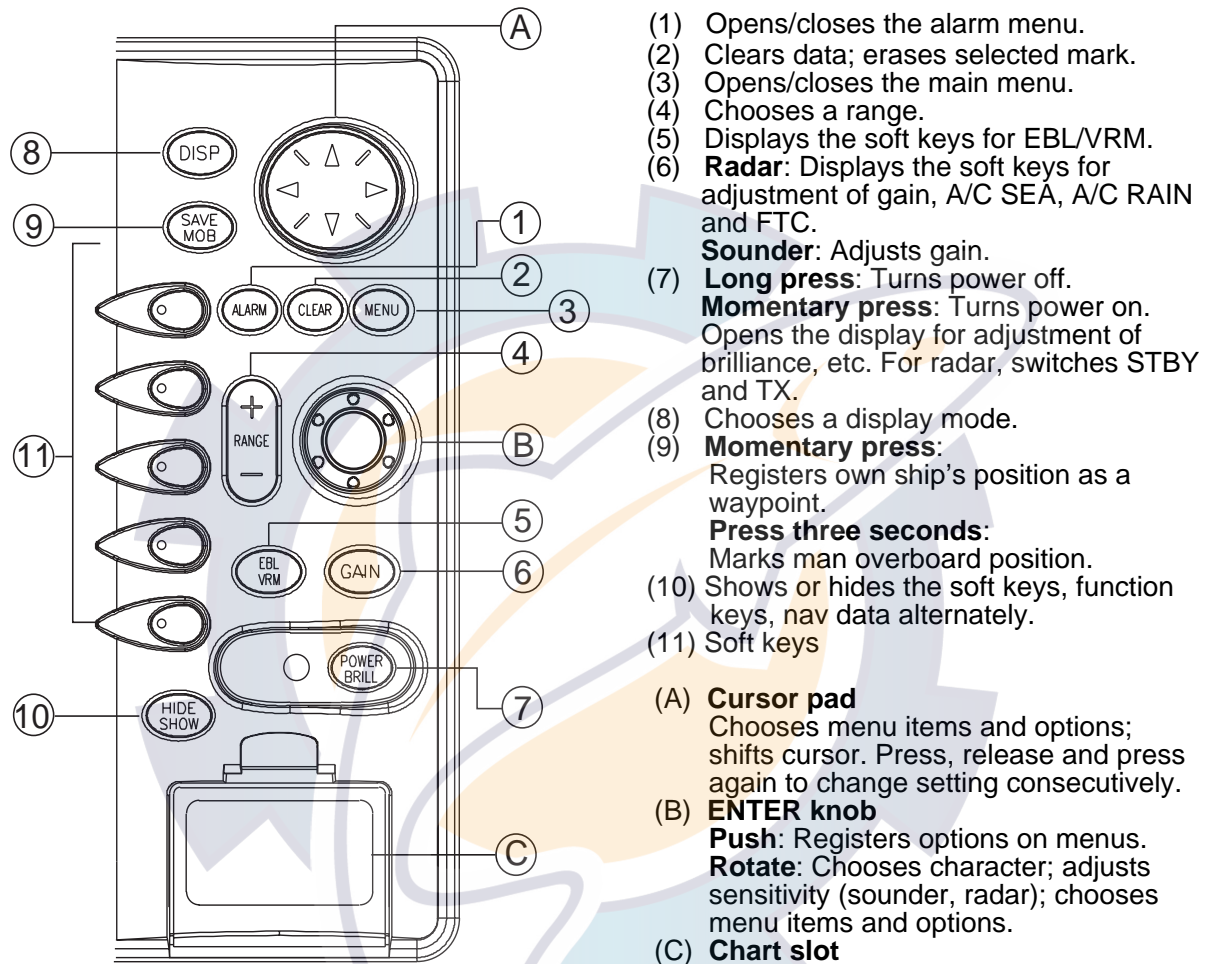

- (1) Opens/closes the alarm menu.
 - (2) Clears data; erases selected mark.
 - (3) Opens/closes the main menu.
 - (4) Chooses a range.
 - (5) Displays the soft keys for EBL/VRM.
 - (6) **Radar:** Displays the soft keys for adjustment of gain, A/C SEA, A/C RAIN and FTC.
Sounder: Adjusts gain.
 - (7) **Long press:** Turns power off.
Momentary press: Turns power on. Opens the display for adjustment of brilliance, etc. For radar, switches STBY and TX.
 - (8) Chooses a display mode.
 - (9) **Momentary press:** Registers own ship's position as a waypoint.
Press three seconds: Marks man overboard position.
 - (10) Shows or hides the soft keys, function keys, nav data alternately.
 - (11) Soft keys
- (A) **Cursor pad**
Chooses menu items and options; shifts cursor. Press, release and press again to change setting consecutively.
- (B) **ENTER knob**
Push: Registers options on menus.
Rotate: Chooses character; adjusts sensitivity (sounder, radar); chooses menu items and options.
- (C) **Chart slot**

Turning the Power On/Off

Turning on the power

Press the **POWER/BRILL** key momentarily.

Turning off the power

Press and hold down the **POWER/BRILL** key until the screen goes off (approx. 3 sec.)

Selecting a Display

1. Press the **DISP** key to open the display selection window.
2. Rotate the **ENTER** knob to choose a basic display screen, and then push it.
3. Rotate the **ENTER** knob to choose a combination display.
4. Push the **ENTER** knob.



FURUNO ELECTRIC CO., LTD.

NISHINOMIYA, JAPAN

<RADAR Operation>

Transmitting, Stand-by

1. Press the **POWER/BRILL** key momentarily to show soft keys.
2. Press the RADAR STBY soft key to highlight TX on its label.
3. Press the RETURN soft key.

To return to Stand-by mode, press the RADAR TX soft key to highlight STBY on its label.

Selecting the Range Scale

Press the **RANGE (+ or -)** key to change the range scale.

Adjusting the Gain

1. Press the **GAIN** key.
2. Press the GAIN soft key.

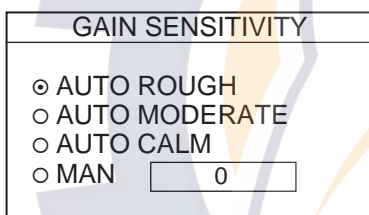

3. Press the **cursor pad** to select AUTO ROUGH, AUTO MODERATE, AUTO CALM or MAN (manual) as appropriate. For manual adjustment, rotate the **ENTER** knob to adjust, while observing the radar echo.
4. Press the **GAIN** key or the RETURN soft key to finish.

Adjusting the A/C SEA, RAIN

1. Press the **GAIN** key followed by A/C SEA or A/C RAIN soft key to open the appropriate setting window.

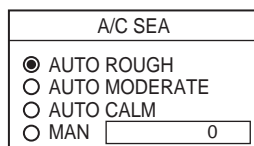

A/C SEA window

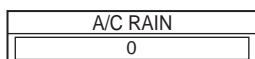

A/C RAIN window

2. For A/C SEA, rotate the **ENTER** knob to choose the appropriate setting. When choosing MAN, rotate the **ENTER** knob to adjust to suppress sea clutter.

3. For A/C RAIN, rotate the **ENTER** knob to adjust.
4. Press the **GAIN** key or RETURN soft key to finish.

Measuring the Range by VRM

1. Press the **EBL/VRM** key followed by VRM1 ON (dotted ring) or VRM2 ON (dashed ring) soft key to open the appropriate VRM.
2. Rotate the **ENTER** knob to place the VRM on the inside edge of a radar target, and read the VRM indication to find range.

To erase a VRM, press appropriate VRM soft key followed by the **CLEAR** key.

Measuring the Bearing

1. Press the **EBL/VRM** key followed by EBL1 ON (dotted line) or EBL2 ON (dashed line) soft key to open the appropriate EBL.
2. Rotate the **ENTER** knob to bisect the radar target with the EBL, and read the EBL indication to find bearing.

To erase an EBL, press appropriate EBL soft key followed by the **CLEAR** key.

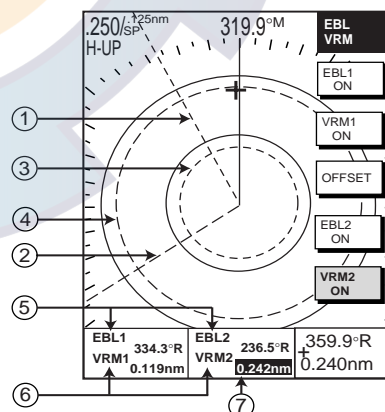

- (1) EBL1 (Dotted line)
- (2) EBL2 (Dashed line)
- (3) VRM1 (Dotted ring)
- (4) VRM2 (Dashed ring)
- (5) EBL bearing
- (6) VRM range
- (7) Active marker is highlighted.

<PLOTTER Operation>

Changing Chart Scale

Press the **RANGE** - key (shrinks the scale, and expands image) or **RANGE +** key (expands the scale, and shrinks image).

Entering a Mark

1. Place the cursor where you want a mark to appear.
2. Press the MARK ENTRY soft key.

Entering a Waypoint at Own Ship Position

Press the **SAVE/MOB** key momentarily to store your position as a waypoint.

Entering a Waypoint with Cursor

1. Press the **MENU** key, WAYPOINTS/ROUTES, WAYPOINTS and WAYPOINT BY CURSOR soft keys in order to open the plotter display.
2. Press the **cursor pad** to place the cursor where you want to enter a waypoint.
3. Press the NEW WAYPOINT soft key.

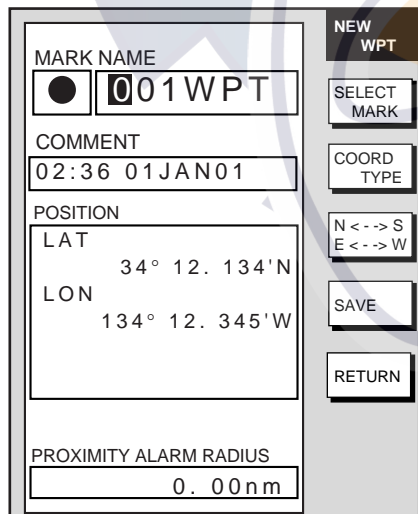

4. Press the SAVE soft key.

Creating a Route

1. Press the **MENU** key, WAYPOINTS/ROUTES, ROUTES soft keys in order to open the ROUTE menu.

2. Press the NEW ROUTE soft key to open the new route entry screen.

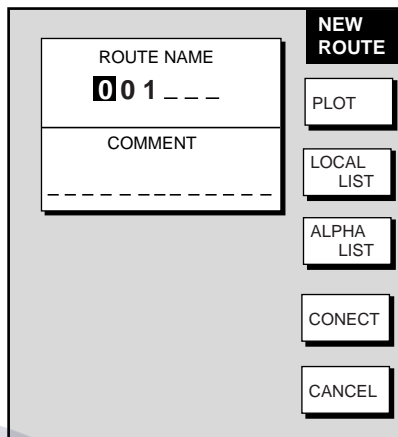

3. Press the LOCAL LIST or ALPHA LIST soft key to open the waypoint list.
4. Press the **cursor pad** to select a waypoint, then press the ADD WPT soft key.
5. Repeat step 4 to complete the route.
6. Press the SAVE soft key to register the route, and then press the **MENU** key.

Navigating to Waypoints

1. Press the **cursor pad** to choose a waypoint on the plotter display.
2. Press the GO TO WPT soft key.

Setting Arrival Alarm

1. Press the **ALARM** key.
2. Choose ARRIVAL ALARM.
3. Press the EDIT soft key to open the arrival alarm window.

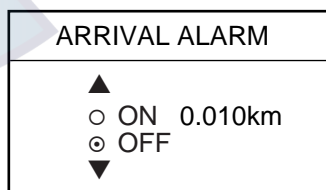

4. Press the **cursor pad** to choose ON.
5. Enter alarm range, and then press the ENTER soft key or **ENTER** knob to register setting.
6. Press the **ALARM** key to finish.

<SOUNDER Operation>

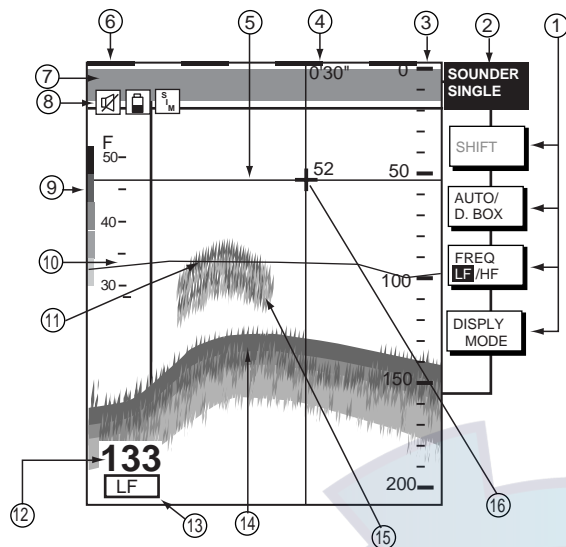

- (1) Soft keys
- (2) Display mode
- (3) Depth scale
- (4) Elapsed time
- (5) Variable Range Marker (white)
- (6) Minute marker
- (7) Zero line
- (8) Icons (alarm, battery, simulation)
- (9) Color bar
- (10) Temperature scale (orange)
- (11) Water temperature graph
- (12) Depth
- (13) Tx frequency
- (14) Bottom echo
- (15) Fish echo
- (16) Cross-hair cursor

Selecting a sounder mode

1. Press the DISPLY MODE soft key to open the display mode window.
2. Press the **cursor pad** or **ENTER** knob to choose a display.
3. Press the RETURN soft key to close the window.

Automatic Sounder Operation

1. Press the AUTO/D.BOX soft key.
2. Press the **cursor pad** or **ENTER** knob to choose CRUISING or FISHING.
3. Press the RETURN soft key.

Manual Sounder Operation

1. Press the AUTO/D.BOX soft key.
2. Choose OFF (MANUAL), and then press the RETURN soft key.

Adjusting the gain

Press the **GAIN** key, and then rotate the **ENTER** knob or press the **cursor pad** to adjust the gain.

Shifting the basic range

Press the SHIFT soft key, and then rotate the **ENTER** knob to adjust the shift range.

Reducing Low Level Noise

1. Press the **MENU** key and SOUNDER MENU soft key in order.
2. Choose CLUTTER, then press the EDIT soft key to open the clutter window.
3. Press the **cursor pad** upward or downward.
4. Press the RETURN soft key followed by the **MENU** key to close the menu.

Picture Advance Speed

1. Press the **MENU** key and SOUNDER MENU soft key in order.
2. Choose PICTURE ADVANCE, and then press the EDIT soft key to open the picture advance window.
3. Press the **cursor pad** to choose speed desired.
4. Press the RETURN soft key followed by the **MENU** key to close the menu.

Activating Sounder Alarms

1. Press the **ALARM** key to open the ALARM menu.
2. Press the **cursor pad** to choose the alarm among BOTTOM, TEMPERATURE, FISH and FISH (B/L).
3. Press the EDIT soft key.
4. Choose ON (for TEMPERATURE, WITHIN RANGE or OUT OF RANGE), and then key in the alarm range.
5. Press the ENTER soft key (or **ENTER** key) followed by the **ALARM** key to close the menu.

PUB. NO. OSE-35550-A
(0503, HIMA) MODEL 1724C SERIES

